

THE PROPERTY OF THE DRAWING IS ESTABLISHED BY LAW. IT IS FORBIDDEN TO PRODUCE OR SHOW IT TO THIRD PART. WITHOUT A WRITTEN AGREEMENT.

Item	Name	Q.ty
1	CA.08.09.018	1
2	CA.08.28.011	1

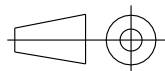
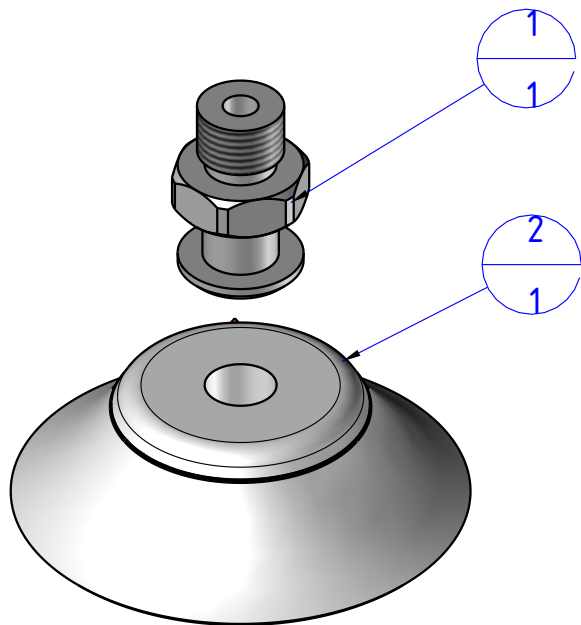
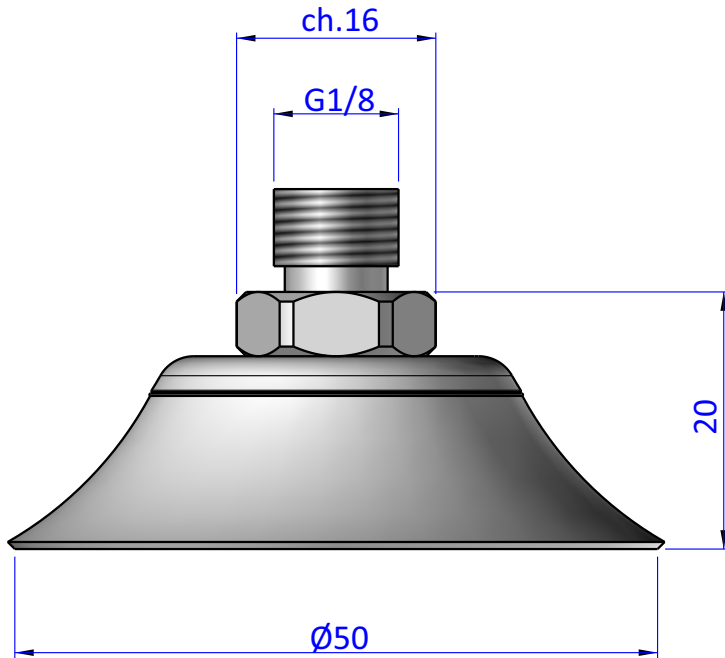

DESIGNED FROM	REVIEW
FPS Automation	A

DATE	WEIGHT
07/01/2021	0,025kg

CODE
KIT.08.28.D50

Format A4  
UNI 936-76

GENERAL TOLERANCE  
UNI - ISO 2768  
CLASSE f

DESCRIPTION  
KIT.08.28.D50